



Glass Hardware for All-Glass Constructions Chalet® PT Swinging Door System

Chalet® PT Swinging Door System

Chalet® PT is a top quality swinging door system with a self-closing function, exclusively for use in living areas and less frequented office spaces.

The system is designed for swinging doors, opening in both directions.

Limiting the door to swing in only one direction is not possible.

The Chalet® swinging door hinges are available in three different versions:

- Without stops in the open position
- Stop in the open position at 90°
- Stop in the open position at 85°

Size and weights per pair of swinging door hinges

- max. door weight: 65 kg
- max. door width: 1000 mm / min. door width: 700 mm
- max. door height: 2500 mm

The hinges are prepared for 10 mm toughened safety glass. The toughened safety glass is to be processed per DIN EN 12150-1:2000.



Swinging Door Hinge "Chalet® PT" · without locking position



Square shape · Adjustable zero position
 Mounting: glass to glass · Door opens both ways · Glass thickness 10 mm · Door width 700 - 1000 mm ·
 Door height max. 2500 mm · Door weight per pair max. 65 kg · Material: brass



| Art. No. | Finish |
|------------|----------------------|
| BK 9433031 | shiny chrome plated |
| BK 9433046 | matt chrome plated |
| BK 9433055 | stainless steel look |

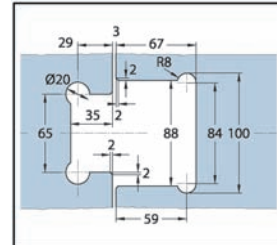
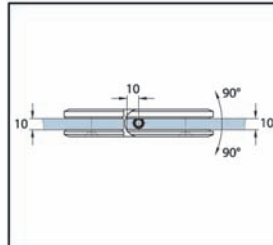
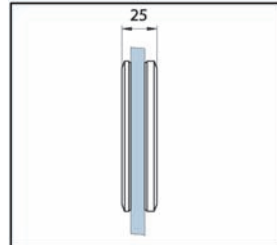
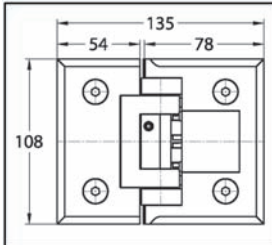

Swinging Door Hinge "Chalet® PT" · with 90° locking position



Square shape · Adjustable zero position
 Mounting: glass to glass · Door opens both ways · Glass thickness 10 mm · Door width 700 - 1000 mm ·
 Door height max. 2500 mm · Door weight per pair max. 65 kg · Material: brass



| Art. No. | Finish |
|------------|----------------------|
| BK 9433131 | shiny chrome plated |
| BK 9433146 | matt chrome plated |
| BK 9433155 | stainless steel look |

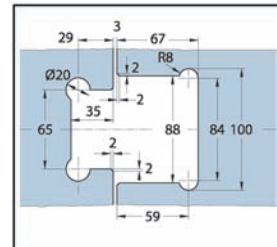
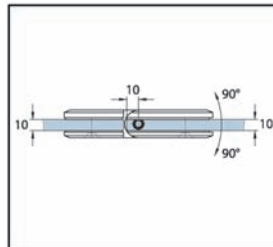
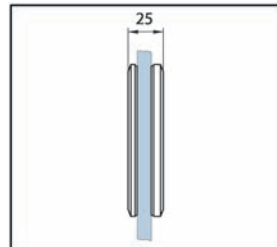
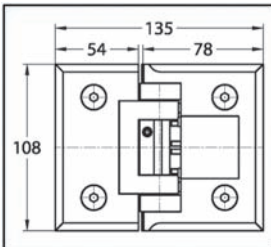

Swinging Door Hinge "Chalet® PT" · without locking position



Square shape · Adjustable zero position
 Mounting: glass to wall · Door opens both ways · Glass thickness 10 mm · Mounting flange 80 mm ·
 Door width 700 - 1000 mm · Door height max. 2500 mm · Door weight per pair max. 65 kg · Material: brass



| Art. No. | Finish |
|------------|----------------------|
| BK 9483031 | shiny chrome plated |
| BK 9483046 | matt chrome plated |
| BK 9483055 | stainless steel look |

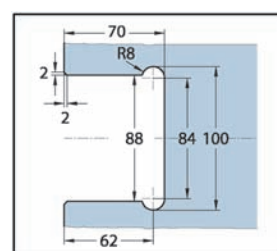
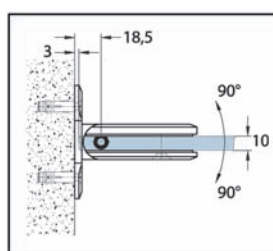
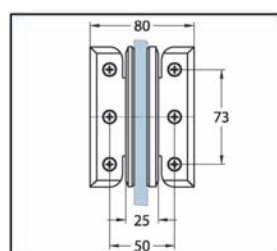
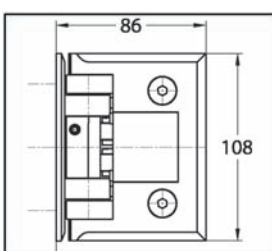

Swinging Door Hinge "Chalet® PT" · with 90° locking position



Square shape · Adjustable zero position
 Mounting: glass to wall · Door opens both ways · Glass thickness 10 mm · Mounting flange 80 mm ·
 Door width 700 - 1000 mm · Door height max. 2500 mm · Door weight per pair max. 65 kg · Material: brass



| Art. No. | Finish |
|------------|----------------------|
| BK 9483131 | shiny chrome plated |
| BK 9483146 | matt chrome plated |
| BK 9483155 | stainless steel look |

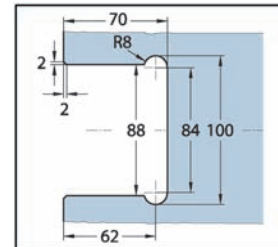
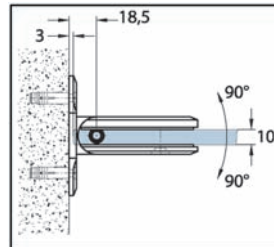
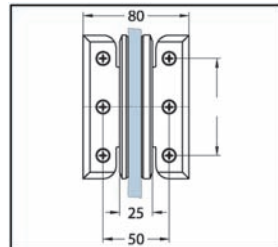
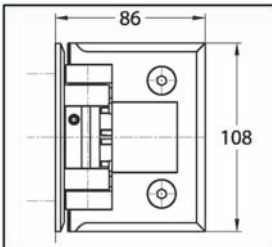

Clamp "Chalet® PT"



Floor mounting left / ceiling mounting right · Square shape · For interior use only
 Glass thickness 10 mm · Material: brass



| Art. No. | Finish |
|------------|----------------------|
| BK 0946031 | shiny chrome plated |
| BK 0946046 | matt chrome plated |
| BK 0946055 | stainless steel look |

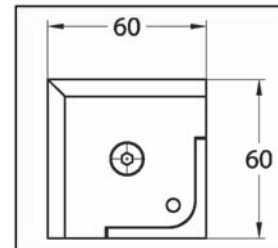
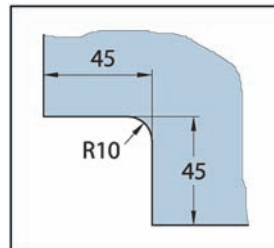
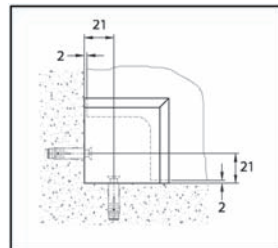
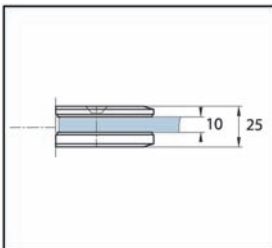

Clamp "Chalet® PT"



Floor mounting right / ceiling mounting left · Square shape · For interior use only
 Glass thickness 10 mm · Material: brass



| Art. No. | Finish |
|------------|----------------------|
| BK 0946131 | shiny chrome plated |
| BK 0946146 | matt chrome plated |
| BK 0946155 | stainless steel look |

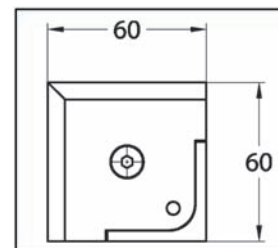
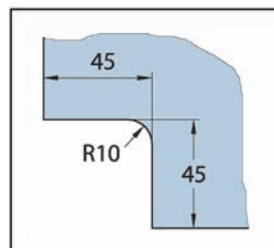
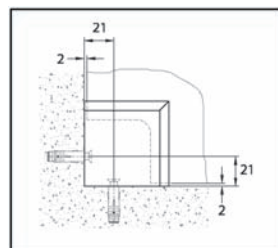
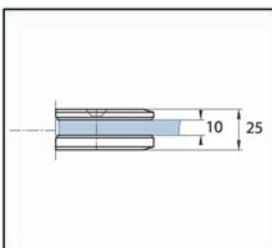

▶ Clamp "Chalet® PT", universal



Square shape · For interior use only
Glass thickness 10 mm · Material: brass



| Art. No. | Finish |
|------------|----------------------|
| BK 0946431 | shiny chrome plated |
| BK 0946446 | matt chrome plated |
| BK 0946455 | stainless steel look |

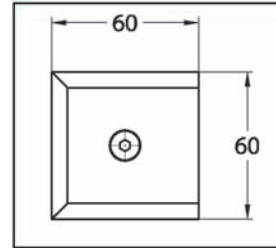
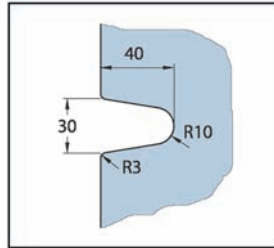
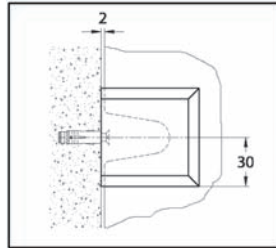
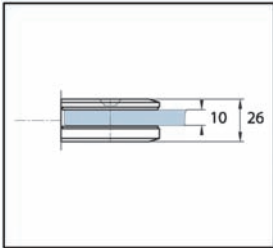

▶ Clamp "Chalet® PT" for Overpanel and Sidelight



Angular shape · For interior use only
Glass thickness 10 mm · Material: brass



| Art. No. | Finish |
|------------|----------------------|
| BK 0946531 | shiny chrome plated |
| BK 0946546 | matt chrome plated |
| BK 0946555 | stainless steel look |

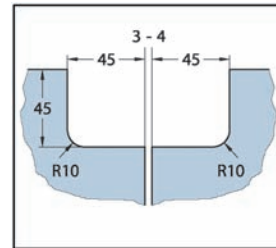
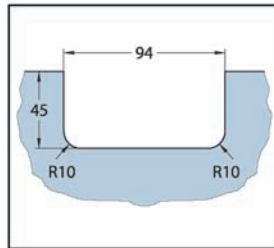
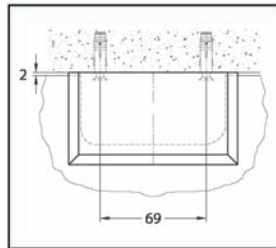
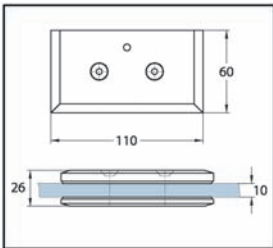

▶ Clamp "Chalet® PT", Glass-Glass Connector



Angular shape · For interior use only
Glass thickness 10 mm · Material: brass



| Art. No. | Finish |
|------------|----------------------|
| BK 0946931 | shiny chrome plated |
| BK 0946946 | matt chrome plated |
| BK 0946955 | stainless steel look |

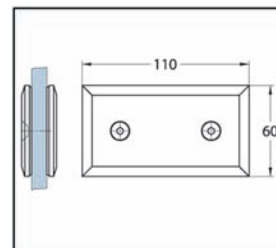
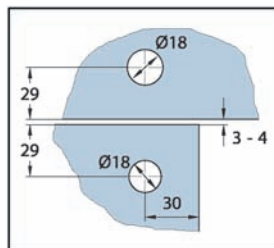
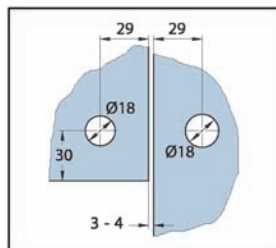
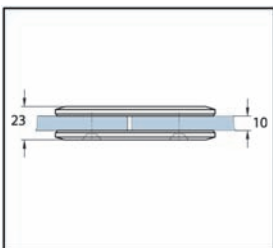

▶ Clamp "Chalet® PT", Glass-Glass Connector



Square shape · For interior use only
 Glass thickness 10 mm · Material: brass

- 1 2 3 4 5

| Art. No. | Finish |
|-------------------|----------------------|
| BK 0947031 | shiny chrome plated |
| BK 0947046 | matt chrome plated |
| BK 0947055 | stainless steel look |

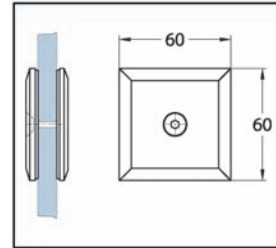
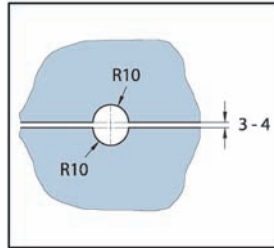
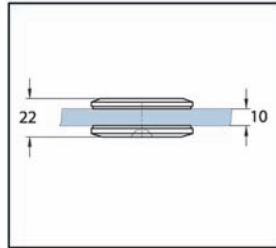

Mounting and Care

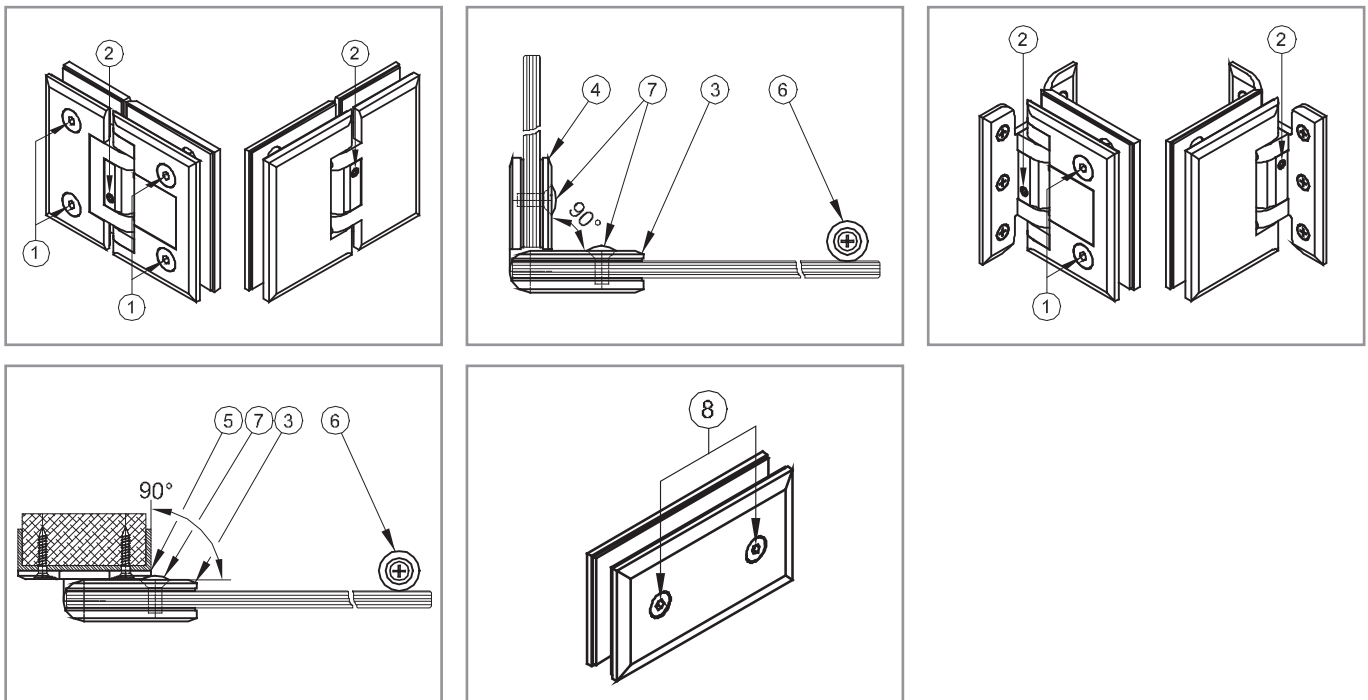

Chalet®PT is a top quality swinging door system with self-closing function, **exclusively for use in living areas and less frequented office spaces**. The system is designed only for swinging doors opening in both directions. Limiting the door to swing only in one direction is not possible. The Chalet® swinging door hinges are available in 3 different versions:

- Without stops in the open position
- Stop in the open position at 90°
- Stop in the open position at 85°

Size and weights per pair of swinging door hinges
 Max. door weight: 65 kg
 Max. door width: 1000 mm / min. door width: 700 mm
 Max. door height: 2500 mm

Type of glass/ Glass thickness / Glass processing
 The hinges are prepared for 10 mm toughened safety glass. Toughened safety glass must be used per DIN EN 12150-1:2000. Exposed glass edges and corners must be ground, polished and arressed so that there is no risk of injury when the system is used or cleaned. Glass positioning other than standard may require different glass processing.

Important information regarding glass drill holes / glass cutouts
 Clean all areas of the glass where hinges, screw connections, etc. will be used. Wherever there are screw connections, be sure to use the supplied plastic pieces or plastic plug sockets as protection between the glass and the fitting (screw).

Mounting of the swinging door hinges and connectors
 Mount each swinging door hinge perfectly level and be sure that the hinge pair is also in perfect vertical alignment to each other! Align the door and tightly affix the fitting caps with the fixing screws [1] (Allen key, size 5). Please wait until all fittings have been mounted and screws have been tightened before snapping the supplied covers [7] onto the fixing screws [1]. Mount the connectors, fastening the fitting caps of the connectors with [8] (Allen key, size 4).
 Note: Be careful not to exceed a 90° angle when opening the door. In other words, do not allow the Chalet® swinging door hinge [3] to touch the side panel hinge [4] or the wall stopper plate [5]. Contact must be prevented, possibly by using a suitable door stopper [6].

Adjustable zero position of the swinging door hinges
 In order to allow precise adjustment of the zero position at installation, the Chalet® swinging door hinges are supplied without pre-setting of the zero position. Thus, the zero position must always be initially set for both Chalet® swinging door hinges (top and bottom fitting) during installation. The zero position of the swinging door hinges is continuously adjustable ($\pm 2.5^\circ$). The setting is fixed with two locking screws [2] (Allen key, size 3). The following 3 steps are necessary to make the adjustment:

- Force must be applied to both screws [2] (Allen key, size 3) during adjustment
- The door must be opened several times in both directions after adjustment
- Both screws [2] (Allen key, size 3) must be firmly retightened.
- Before readjusting the setting, both screws must be loosened.

Important: DO NOT loosen the M6 safety screw for the pivot!

When installation is finished, inspect all fixing screws to ensure that they are tight. If necessary, tighten them again. The statically required mounting materials for installation of the swinging door hinges and connectors to load-bearing structures must be determined by the person responsible for the installation.

Mounting
 Mounting should only be carried out by a qualified professional.

Care instructions
 Chalet®PT swinging door fittings should only be cleaned with warm water and a damp, soft cloth (microfibre) and dried, if necessary. Do not use caustic, aggressive cleaners, alkaline cleaners or cleaners containing chlorine. Abrasives (steel wool, for example) or solvents also should not be used.

Germany

Bohle AG
Dieselstraße 10
D - 42781 Haan

T +49 2129 5568-0
F +49 2129 5568-201

info@bohle.de

United Kingdom and Ireland

Bohle Ltd.
Fifth Avenue
Tameside Park · Dukinfield
Cheshire · SK16 4PP

T +44 161 3421100
F +44 161 3440111

info@bohle.ltd.uk

South Africa

Bohle Glass Equipment (Pty) Ltd.
Unit 3, Graphite Industrial Park
Fabriek Street,
Strijdom Park 2125, Gauteng

T +27 11 792-6432
F +27 11 793-5634

info@bohle.co.za

USA

Bohle America, Inc.
10924 Granite Street
Suite 200
Charlotte, NC 28273

T +1 704 247 8400
F +1 704 247 8420

info@bohle-america.com